

EE75

Highly Accurate Air/Gas Velocity Sensor for Industrial Applications

The EE75 air velocity (v) and temperature (T) sensor is optimized for best measurement results in challenging air flow applications in most various industries.

Outstanding Measurement Performance

With its multipoint v factory adjustment the EE75 meets the highest accuracy requirements. The E+E thin film sensing element employed operates on the hot film anemometer principle, which stands for excellent accuracy from 0.06 m/s (12 ft/min) up to 40 m/s (8000 ft/min) and low angular dependency. The integrated temperature compensation combined with the robust mechanical design, makes the EE75 capable of process temperatures from -40 °C (-40 °F) up to 120 °C (248 °F).

Versatility

The EE75 is available for duct mount as well as with remote probe in various probe lengths. The remote probe types feature different cable lengths and pressure tight versions up to 10 bar (145 psi). The IP65/NEMA 4 rated metal enclosure facilitates easy installation and maintenance. The v and T measured data is available on two current or voltage analogue outputs. In addition to v and T values EE75 calculates the volume flow V' in m³/min or ft³/min.

Configurable and Adjustable

The setup and adjustment of the EE75 can be easily performed using the configuration software and USB interface cable included in the scope of supply.

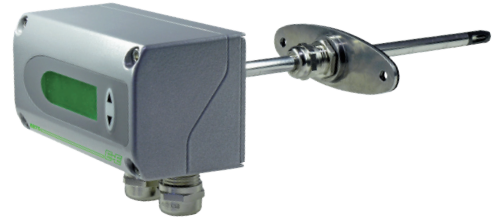

Features

EE75 Sensor

- » Highly accurate over the entire working range
- » Combined v and T measurement
- » Integrated T compensation
- » Optional display with backlight and menu buttons
- » Easy mounting and maintenance
- » Voltage or current output, selectable
- » Low-flow suppression
- » Calculation of volume flow V'

EE75 Sensing Head and Probe

- » Measuring range from -40 °C (-40 °F) up to 120 °C (248 °F) and 10 bar (145 psi)
- » Accurate measurement of air flows from 0.06 m/s (12 ft/min) up to 40 m/s (8000 ft/min)
- » Low angular dependency
- » Long-term stable



Application Specific Design

- » Duct mount and remote probe types with different probe lengths
- » Pressure tight remote probes up to 10 bar (145 psi)
- » Various cable lengths for remote probe types
- » Process connection with stainless steel flange or G1/2" ISO/1/2" NPT thread

Adjustment and Configuration

- » v and T adjustment
- » Scalable measuring range
- » Selectable output signal
- » Response time
- » Calculation of volume flow

Inspection Certificate

- » according to DIN EN 10204-3.1 with three v points

Technical Data

Measurands

Air velocity

Measuring range	0...2 m/s (0...400 ft/min)	
	0...10 m/s (0...2000 ft/min)	
	0...40 m/s (0...8000 ft/min)	
Accuracy ¹⁾		
<i>in air at 25 °C (77 °F) and 1013 hPa (14.7 psi)</i>		
0.06...2 m/s (12...400 ft/min):	± 0.03 m/s (6 ft/min)	
0.15...10 m/s (30...2000 ft/min):	± (0.10 m/s (20 ft/min) + 1 % of mv)	
0.20...40 m/s (40...8000 ft/min):	± (0.20 m/s (40 ft/min) + 1 % of mv)	mv = measured value
Uncertainty of factory calibration	± 1 % of mv, min. 0.015 m/s (3 ft/min)	
Dependency of inflow angle (α):	< 3 % for α < 20°	
of inflow direction:	< 3 %	
Response time t ₉₀ , typ.	< 1.5...40 s (Factory setting: 1.5 s, configurable via EE-PCS Configuration Software)	



Temperature

Measuring range	-40...120 °C (-40...248 °F)	
Accuracy, typ. ²⁾	±0.5 °C (±0.9 °F)	
<i>in air at 25 °C (77 °F)</i>		
Response time t ₉₀ , typ.	10 s	
Temperature dependency electronics, typ.	± 0.005 % of mv/K deviating from 25 °C (77 °F)	mv = measured value (v or T)
Temperature dependency probe, typ.	± 0.1 % of mv/K deviating from 25 °C (77 °F)	mv = measured value (v or T)

Outputs

Analogue	0 - 10 V	-1 mA < I _L < 1 mA
	0 - 20 mA / 4 - 20 mA (3-wire)	Load resistance ≤ 350 Ω

General

Power supply class III  ³⁾	24 V DC ±20 %	
Current consumption, typ.	< 100 mA	
With display	< 160 mA	
Electrical connection	Screw terminals max. 1.5 mm ² (AWG 16)	
Protection rating enclosure	IP65/NEMA 4	
Material		
Enclosure	Metal (AlSi ₃ Cu)	
Sensing probe	Stainless steel 1.4404	
Sensing head	PBT	
Temperature working range		
Probe cable:	-40...105 °C (-40...221 °F)	
Enclosure:	-40...60 °C (-40...140 °F)	
Enclosure with display:	-30...60 °C (-22...140 °F)	
Humidity working range	0...95 %RH non-condensing	
Pressure range	T2, T3:	Atmospheric pressure, 700...1300 hPa (10.2...18.9 psi)
	T26:	Pressure tight up to 10 bar (145 psi)
Electromagnetic compatibility	EN 61326-1 EN 61326-2-3 Industrial Environment FCC Part15 Class B ICES-003 Class B	
Storage conditions	-20...70 °C (-40...158 °F)	
	0...95 % RH, non-condensing	
Configuration and adjustment	Configuration software and USB interface cable included in the scope of supply	

1) The accuracy statement includes non-linearity, hysteresis and repeatability.

2) T accuracy: at air flows ≥ 0.45 m/s (886 ft/min)

3) USA & Canada: class 2 supply required

Angular Dependency

The innovative design of the probe head minimises the effect of the angle of inflow (yaw angle) on the measuring result. The deviation of the measuring value remains < 3 % up to a yaw angle α of $\pm 20^\circ$ between the direction of inflow and the sensor element's longitudinal axis.

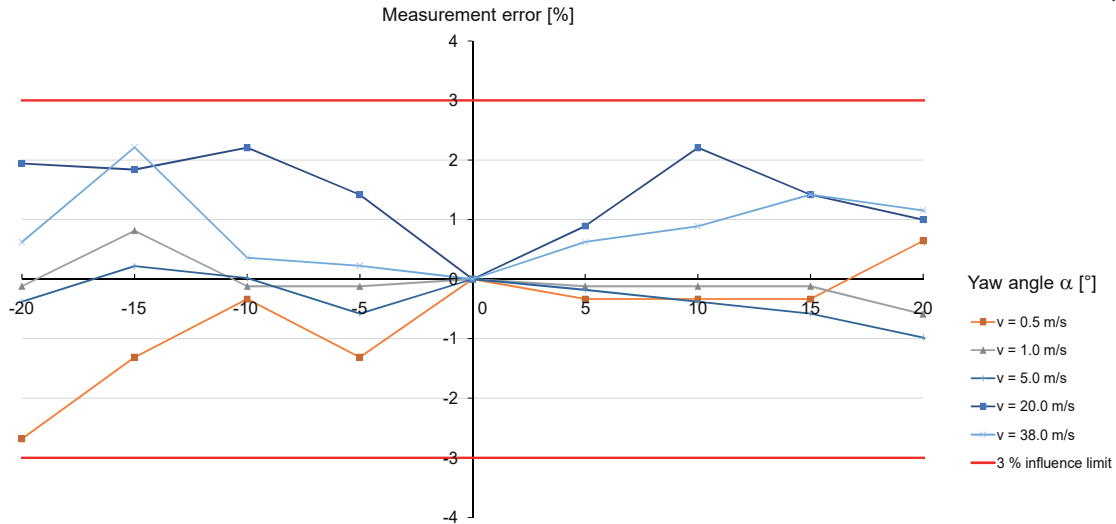
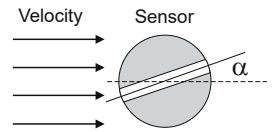

Dimensions

Values in mm (inch)

Enclosure

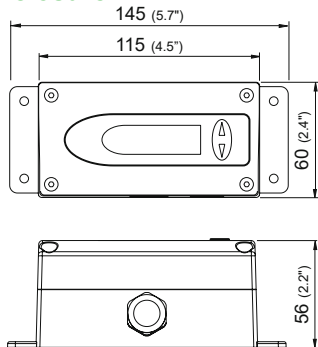

Mounting flange for Types T2 and T3 (included in the scope of supply)

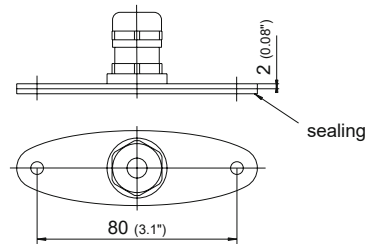

Type T2 Duct Mount

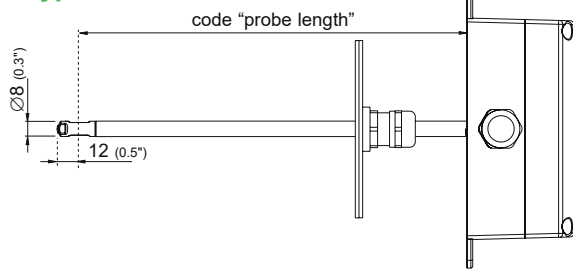

Type T3 Remote Probe

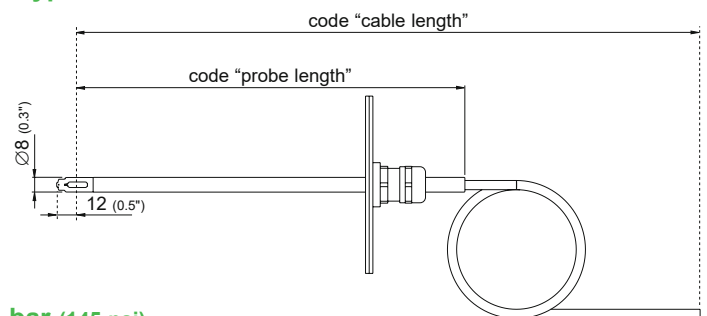

Type T26 Remote Probe, pressure tight up to 10 bar (145 psi)

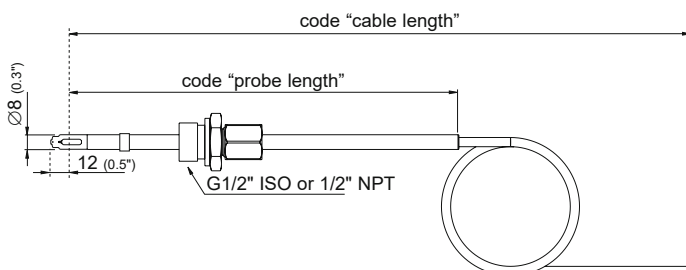

Ordering Guide

		EE75-			
Hardware Configuration	Type	Duct mount Remote probe Remote probe, pressure tight, 10 bar (145 psi)	T2	T3	T26
	Output ¹⁾	0 - 10 V 4 - 20 mA	A3 A6		
	Measuring range	0...2 m/s (0...400 ft/min) 0...10 m/s (0...2000 ft/min) 0...40 m/s (0...8000 ft/min)	HV26 HV30	HV23 HV26 HV30	HV30
	Probe length	100 mm (4") 200 mm (7.9") 400 mm (15.8") 600 mm (23.6")	L200 L400	L100 L200 L400 L600	L200 L400 L600
	Cable length	2 m 5 m 10 m		K2 K5 K10	K2 K10
	Display	Without With	no code D2		
	Process connection	G1/2" ISO 1/2" NPT			PA29 PA30
	Electrical connection	Cable glands 1 plug for power supply and outputs 2 plugs for power supply/outputs and Modbus	no code E4 E6	no code E4 E6	no code
	Software Setup	Output 1 measurand ²⁾	Temperature [°C] Temperature [°F] Air velocity [m/s] Air velocity [ft/min] Volume flow [m ³ /min] Volume flow [ft ³ /min]	no code MA2 MA20 MA21 MA89 MA90	
Scaling 1 low		0 Value	no code SALValue		
Scaling 1 high		50 Value	no code SAHValue		
Output 2 measurand		Air velocity [m/s] Air velocity [ft/min] Temperature [°C] Temperature [°F] Volume flow [m ³ /min] Volume flow [ft ³ /min]	no code MB21 MB1 MB2 MB89 MB90		
Scaling 2 low		0 Value	no code SBLValue		
Scaling 2 high		Value	SBHValue		
Medium		Air Nitrogen CO ₂ Argon	no code FU2 FU3 FU7		
Duct cross section ³⁾		Value in mm ² /inch ²	DCValue		

1) Applies to both outputs

2) Measurands for output 1 and output 2 need to be either metric or non-metric

3) Only in combination with Volume Flow measurement Mx89: value in mm² / Mx90: value in inch²

Ordering Example

EE75-T26A6HV30L400K10D2PA29SAL-20SAH120SBH20

Type: Remote Probe, pressure tight, 10 bar
 Output: 4 - 20 mA
 Measuring Range: 0...40 m/s (0...8000 ft/min)
 Probe length: 400 mm
 Cable length: 10 m
 Display: With Display
 Process connection: G1/2" ISO
 Electrical connection: cable glands
 Output 1 measurand: Temperature °C
 Scaling 1 low: -20 °C
 Scaling 1 high: 120 °C
 Output 2 measurand: Air velocity m/s
 Scaling 2 low: 0 m/s
 Scaling 2 high: 20 m/s
 Medium: Air
 Duct cross section: Not applicable

EE75-T2A6HV26L600E4MA21SAH2000MB90SBH2000FU2DC200

Type: Duct mount
 Output: 4 - 20 mA
 Measuring Range: 0...10 m/s (0...2000 ft/min)
 Probe length: 600 mm
 Cable length: Not applicable
 Display: No Display
 Process connection: Not applicable
 Electrical connection: 1 plug for power supply and outputs
 Output 1 measurand: Air velocity ft/min
 Scaling 1 low: 0 ft/min
 Scaling 1 high: 2000 ft/min
 Output 2 measurand: Volume flow ft³/min
 Scaling 2 low: 0 ft³/min
 Scaling 2 high: 2000 ft³/min
 Medium: Nitrogen
 Duct cross section: 200 inch²